

Trademark Information

LAUNCH is a registered trademark of LAUNCH TECH. CO., LTD. (LAUNCH for short) in China and other countries. All other LAUNCH trademarks, service marks, domain names, logos, and company names referred to in this manual are either trademarks, registered trademarks, service marks, domain names, logos, company names of or are otherwise the property of LAUNCH or its affiliates. In countries where any of the LAUNCH trademarks, service marks, domain names, logos and company names are not registered, LAUNCH claims other rights associated with unregistered trademarks, service marks, domain names, logos, and company names. Other products or company names referred to in this manual may be trademarks of their respective owners. You may not use any trademark, service mark, domain name, logo, or company name of LAUNCH or any third party without permission from the owner of the applicable trademark, service mark, domain name, logo, or company name. You may contact LAUNCH by visiting Launch at <http://www.cnlaunch.com>, or writing to LAUNCH Industrial Park, North Wuhe Avenue, Banxuegang Industrial Park, Longgang Dist., Shenzhen, P.R. China, to request written permission to use Materials on this manual for purposes or for all other questions relating to this manual.

Copyright Information

Copyright © 2000 by LAUNCH TECH. CO., LTD. All rights reserved. No part of this publication may be reproduced, stored in a retrieval system, or transmitted in any form or by any means, electronic, mechanical, photocopying, recording or otherwise, without the prior written permission of LAUNCH. The information contained herein is designed only for the use of this unit. LAUNCH is not responsible for any use of this information as applied to other units.

Neither LAUNCH nor its affiliates shall be liable to the purchaser of this unit or third parties for damages, losses, costs, or expenses incurred by purchaser or third parties as a result of: accident, misuse, or abuse of this unit, or unauthorized modifications, repairs, or alterations to this unit, or failure to strictly comply with LAUNCH operating and maintenance instructions.

LAUNCH shall not be liable for any damages or problems arising from the use of any options or any consumable products other than those designated as Original LAUNCH Products or LAUNCH Approved Products by LAUNCH.

General Notice

Other product names used herein are for identification purposes only and may be trademarks of their respective owners. LAUNCH disclaims any and all rights in those marks.

Disclaimer

- To take full advantage of the unit, you should be familiar with the engine.
- All information, illustrations, and specifications contained in this manual are based on the latest information available at the time of publication. The manufacturer reserve the right of modify this manual and the machine itself with no prior notice.

This unit is made for the purpose of persons who have special techniques and certifications.

Safety Precautions

Read all service procedures and precautions, installation instructions and equipment operating manuals thoroughly. Failure to observe these precautions, or the improper use of equipment, could result in property damage, serious injury or death. Never allow improperly trained personnel to perform these procedures or operate the equipment.

- Read the operating instructions before attempting to operate the unit. Keep this manual with the unit at all times.
- Care must be taken as burns can occur from touching hot parts of the equipment or in the engine.
- Do not operate equipment with a damaged cord or if the equipment has been dropped or damaged until it has been examined by qualified service personnel.
- Do not hang cords over the edge of the table, bench or counter, or come in contact with hot manifolds or moving fan blades.
- If an extension cord is needed, a cord with a rated current equal to or greater than that of the equipment should be used. Cords rated for lower current than that of the equipment may overheat.
- Always unplug equipment from electrical outlet when the machine is not in use. Never pull the cord when unplugging from the outlet.
- Make sure the equipment cools down completely before putting it away. Loop cord loosely around the equipment when storing.
- To protect against risk of fire, do not operate the equipment in the vicinity of open container containing flammable liquid (gasoline).
- Make sure that the unit is in the well-ventilation area when operating the fuel engine.
- Keep lighted cigarettes, sparks, flames or other ignition sources away from fuel systems at all times.

- Keep hair, clothes, fingers or the other body parts away from the running parts of the unit.
- In order to avoid electric shock, keep away from the damp part of a working unit and avoid exposing it to the rain.
- Please operate the unit according to the operation procedures in the manual. Only use the accessories recommended by the manufacturer.
- Do not switch on the ultrasonic system when there is no ultrasonic detergent in the ultrasonic cleaning chamber. Otherwise, damage to the ultrasonic cleaner can be resulted.
- Keep the unit well grounded.
- Provide ventilation through an exhaust gas removal system, ventilation fans or large doors. Carbon monoxide gas, which is odorless and colorless, can cause serious illness, injury or death.
- Avoid contacting hot surfaces such as exhaust pipes, radiator, etc.
- Before testing vehicles, put the transmission lever in NEUTRAL position, apply the parking brake, and block the front wheels.
- ALWAYS WEAR SAFETY GOGGLES. Common used glasses are NOT safety glasses.
- When disconnecting any connector of the pressurized fuel hose, wrap the connector with towel to prevent the fuel from spurting out. Spurred fuel may cause personal injury or fire.
- Test liquid is used by the main unit. Detergent is used for on-vehicle cleaning. The ultrasonic cleaning uses specified ultrasonic detergent (It can be replaced by detergent provided together with the unit).



Note: Specifying operations that require attention when operating the equipment.



Warning: Specifying a possible hazard that could result in damage to the machine or personal injury.

PLEASE SAVE THESE INSTRUCTIONS

Table of Contents

Introduction	2
Functions	2
Features	2
Specifications	2
Structure.....	3
Overview.....	3
Control Panel.....	3
Installation & Connection.....	4
1. CNC-602A Installation	4
2. CNC-601A/801A Installation	4
3 Ordinary Connection.....	4
Operating Procedures	4
Preparation	4
Cleaning & testing sequences	5
Tidy up after operating.....	5
Operation	5
Ultrasonic Cleaning	5
Uniformity/Sprayability Test	5
Leakage Test	7
Injecting Flow Test.....	7
Auto. Test.....	7
On-Vehicle Cleaning.....	10
Maintenance	11
1. Transporting and Storing	11
2. Vulnerable Parts	11
3. Connection Diagram of Driving Board	12
4. Troubleshooting & Precautions.....	12
Installation and Adjustment	14
1. Parts List and Structure Diagram of Fuel Path	14
2. Parts List and Structure Diagram of Fuel Distributor	15
3. Parts List and Structure Diagram of Fuel Tank	15
4. Main Components and Parts	16
Appendix 1: List of Optional Parts	18
Appendix 2: Electrical Diagram	20
Appendix 3: Fuel Path Diagram	20
Appendix 4: Pressure Gauge of Injection System	21

Special note: This user's manual is an introduction to the structure, functions, operations, cautions, maintenance and troubleshooting for the proper use of the equipment, LAUNCH Company retain the right of changing product design and specifications, The actual configuration according to the packing list.

Introduction

Thank you for purchasing the Injector Cleaner & Tester manufactured by LAUNCH TECH CO., LTD. Developed with the technology of ultrasonic cleaning and fuel pressure control, this equipment is an advanced electromechanical product, which can clean and test injectors by simulating engine working conditions. It can also perform cleaning on the injectors and fuel supply system on vehicle.

Functions

- **Ultrasonic cleaning:** To perform simultaneous cleaning on several injectors and to remove the carbon deposits on the injector completely.
- **Uniformity/Sprayability test:** To test the uniformity of injecting amount of each injector, and to monitor the spraying status of each injector with the help of backlight. This test is also for reverse flush.
- **Leakage test:** To test the sealing and dribbling conditions of injectors under system pressure.
- **Injecting flow test:** To check the injecting amount of the injector in 15 seconds of constant injection.
- **Auto. test:** To test injectors by simulating different working conditions.
- **On-vehicle cleaning:** The unit is equipped with various adaptors and couplers that facilitate cleaning on the injectors on vehicle.

Features

- Adopting the powerful ultrasonic cleaning technology, The equipment offers complete cleaning to the injectors.
- Fuel pressure control through microcomputer offers stable pressure control and large adjustable range, which is suitable for all EGI vehicles and can help to achieve automatic cleaning and testing of injectors.
- With the help of microcomputer control and digital display, The equipment makes possible automatic cleaning, testing injectors and real-time monitoring of the dynamic values.
- Automatic fuel draining through preset programs for some test items. Test liquid/detergent can also be drained by pushing a button on the control panel after the test.
- Adopting humanization design can make the system pressure fast restored to the default values.

Specifications

Working conditions:

- Temperature: -10~+40 ;
- Relative humidity: < 85%;
- Intensity of outer magnetic field: < 400A/m;
- No naked flame within 2m.

Specifications:

- Main unit power supply:
AC220V±10%, 50/60Hz;
AC110V±10%, 50/60Hz.
- Main unit power:
230W (CNC-601A/ 602A)
280W (CNC-801A)
- Ultrasonic cleaner power: 100W;
- Simulated RPM range: 10 ~ 9990rpm; step: 10rpm;
- Time range: 1 ~ 9999s;
- Pulse width: 0.5 ~ 25ms; step 0.1 ms;
- Fuel tank capacity: 4700ml (601A/801A)
4000ml (602A)
- Dimensions: 400mm×410mm×580mm (602A)
500mm × 580mm × 1400 mm (601A/801A)
- Weight: 27kg (CNC-602A)
95kg (CNC-601A/801A)

Structure

Overview

CNC series Injector Cleaner& Tester structure has been shown in Fig.01.

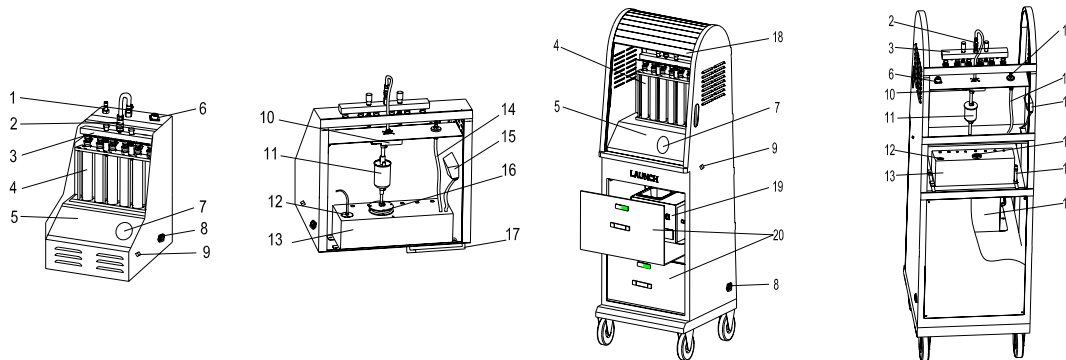

Fig.01

1-Return fuel connector; 2- Outlet fuel connector; 3- Top-supply fuel distributor assembly; 4- Measuring cup; 5- Control panel; 6- Socket for pulse signal cable; 7- Pressure gauge; 8- Power socket & Fuse; 9- Power switch
 10- Tee joint; 11- Filter; 12- Fluid level switch; 13- Tank; 14- Return hose; 15- Fuel filler; 16- Pump; 17- Fluid level indicator/Fuel draining hose; 18- Sliding curtain; 19- Ultrasonic cleaner; 20- drawer.

Note:

The illustrations in this manual may be slightly different from the actual product!

Control Panel

The control panel is shown in Fig.02 (Apart from models signs, the CNC-601A & CNC-602A & CNC-801A control panel is identical.).

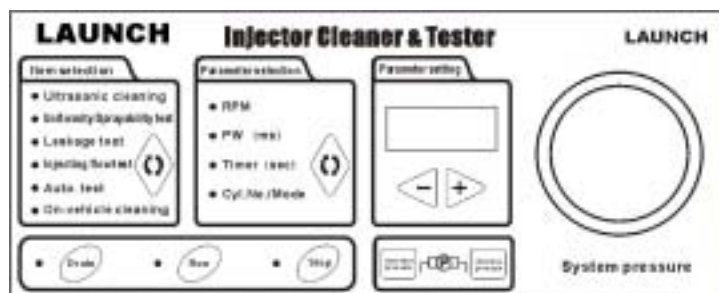







Fig.02

The control panel can be divided into five areas as shown in the following table:

Area	Description
Item selection	Select a function by pressing a [] key. The corresponding indicator will light.
Parameter selection	Select a parameter by pressing a [] key. The corresponding indicator will light.
Parameter setting	After selecting function and parameter, the user can set the parameter value by pressing []/[]key. ([]key is for increasing, []key is for decreasing.) The set value will be displayed on LED screen.
System control	System control area below the Item selection & Parameter selection area, which control the draining stop and run of the equipment.
System pressure control	System pressure control area below the Parameter setting area, which can adjust the system pressure by pressing [increase pressure] / [decrease pressure] key.

Installation & Connection

1. CNC-602A Installation

- 1) Move the machine onto the workbench after unpacking and loosen the strips on the outlet hoses.
- 2) Mount the pulse signal cables onto the socket on the right top side of the machine.
- 3) Take the two adjusting bolts out from the kit and install them to the press plate on the top of the glass tube.
- 4) Take the two knurled nuts from the kit and install them on the adjusting bolts.
- 5) Take the fuel distributor from the kit and install it on the knurled nuts and tighten them with the pressing bolts.

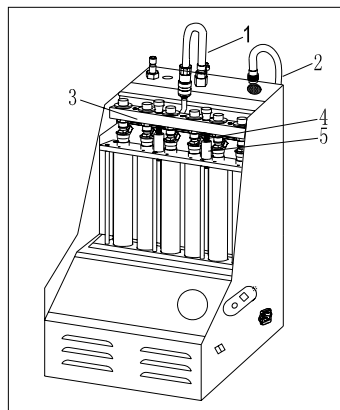

Fig.03

1-Outlet hose; 2-Pulse signal cables; 3-Fuel distributor assembly; 4-Adjusting bolts; 5-Knurled nut.

2. CNC-601A/801A Installation

- 1) Take the pulse signal cables from the box and insert it into the socket on the top right side of the machine and tighten it.
- 2) Take the pulse signal cables from the box and insert it into the socket on the right upper of the ultrasonic cleaner and tighten them.
- 3) Take the two adjusting screws out from the box and install them to the press plates on the top of the glass tubes.
- 4) Take the two knurled nuts from the box and install them on the adjusting screws.
- 5) Take the fuel distributor from the box and install it on the knurled nuts and tighten them with the pressing screws.

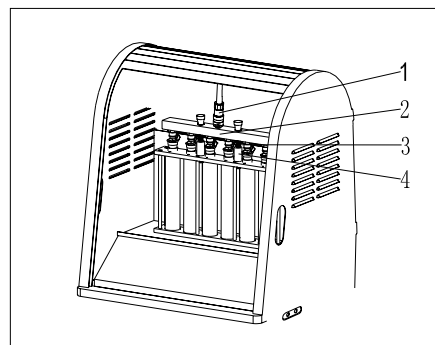

Fig.04

1-Outlet hose; 2-Top-supply fuel distributor assembly; 3-Adjusting screw; 4-Knurled nut.

3 Ordinary Connection

- 1) Take the power cables out from the kit and insert it into the input socket at the bottom of the unit.
- 2) Take the power cables out from the kit and insert it into the input socket of the ultrasonic cleaner.

Operating Procedures

Preparation

- 1) Remove the injector from the vehicle engine to check the o-rings inside for damage. Replace the damaged O-ring with another same type O-ring to avoid leakage during testing. Put the outside of injectors in gasoline or detergent, and wipe them with soft cloth after cleaning the outside oil sludge carefully.
- 2) Check the liquid level and refill test liquid when necessary. Fill the test liquid through the filler on the side of the unit and observe the liquid level in the fuel level viewer. In most cases, filled the liquid up to 1/2 of the tank capacity.

- 3) Turn on the power switch on the right of the Cabinet.
- 4) Fill ultrasonic detergent into the ultrasonic cleaning launder so that the needle valve of the injector is covered by the detergent.
- 5) Connect the injectors with the right couplers.

ⓘ Note:

Test liquid and detergent are provided together with the unit. The test liquid is used for uniformity/sprayability test, leakage test, injecting flow test and auto. test. The mixture of fuel and detergent is used in on-vehicle cleaning. The ultrasonic cleaning uses special injector detergent (or test liquid and detergent that comes with the unit).

Cleaning & testing sequences

A complete cleaning and testing sequence shown below should be followed:

- Ultrasonic cleaning;
- Uniformity/Sprayability test;
- Leakage test;
- Injecting flow test;
- Auto. test.

Select the corresponding parameter and set up according for various tests. For detailed operations, please refer to "Operation" part.

Tidy up after operating

Tidy-up should be done after cleaning and testing is completed:

- Press [Drain] button to drain the test liquid into fuel tank.
- Switch off the power and unplug from the socket.
- Drain the injector detergent to its original bottle and then wipe the ultrasonic cleaner with soft cloth.
- Clean the Injector Cleaner & Tester control panel with soft cloth.
- Drain the test liquid from the tank into a container to avoid volatilization. Store the test liquid in a safe place if it can be used again, or dispose of it in accordance with relevant regulations if it is too dirty.

Operation

Ultrasonic Cleaning

Injector Cleaner takes advantage of the penetrability and cavitation impact wave caused by ultrasonic wave traveling through the medium to provide powerful cleaning on objects with complex shapes, cavities and pores, so that the stubborn carbon deposits can be removed from the injectors.

Procedures

- 1) Connect the power supply: connect one end of the power cable to the power socket on ultrasonic cleaner and the other end to power socket.
- 2) Place the injectors which have gone through surface cleaning in a launder.
- 3) Add enough injector detergent into ultrasonic cleaner so that the liquid level is about 20mm above the needle valve of injectors.
- 4) Plug the injector pulse signal wires to injectors respectively then turn on the power switch of the ultrasonic cleaner.
- 5) Select [Ultrasonic cleaning] in the function column by pressing "⏏" key. Select [Timer] in the parameter column, and set the timer (the default time is about 10 minutes) in the value column. Press [Run] button

to start cleaning.

- 6) When the time is up, Injector Cleaner & Tester will stop automatically as the beeper rings.
- 7) Turn off the power of the ultrasonic cleaner, take the injectors out of the launder and wipe them with a dry soft cloth. Get ready for next operation.

① Note:

- ◆ *Before the injector detergent is added into ultrasonic cleaner, do not turn on the ultrasonic cleaner. Otherwise, damage may be incurred.*
- ◆ *Do not dip the pulse signal cables plug and the injector's body into the detergent.*

Uniformity/Sprayability Test

Uniformity test is to find out if the flow of different injectors meets the requirement or specifications under the same working condition. This test can reflect the comprehensive influences on the injector caused by electrical nature, bore variation and clogging. Sprayability test is to inspect the spraying performance by observing the injectors.

Installing and testing procedures for top-supply injectors

- 1) Choose the fuel distributor stopper (4) from the coupler box and mount a proper O-ring on it. Remember to apply a little lubricating grease on the O-ring. Mount the fuel distributor stopper (4) onto the top-supply fuel distributor.
- 2) Mount the crescent plate (3) and tighten it with a plate bolt (1).
- 3) Choose a proper adaptor (5) according to the injector type and mount it to the corresponding coupler under the top-supply fuel distributor.
- 4) Install the injectors in forward direction (Apply a little lubricating grease on the O-ring.)
- 5) Install the top-supply fuel distributor and the injector on the fuel distributor supporter with a proper adjustable screw and knurled nuts, and tighten two raffle screws (black). See Fig. 05.
- 6) Connect the injector pulse signal wire.
- 7) Before doing this test, press [Drain] button to drain the test liquid from the measuring cup if there is any.
- 8) Choose [Uniformity/Sprayability test] on the control panel, set corresponding parameters (consult the appendix for pressure setting, consult vehicle manuals for other parameters as needed), and then press [Run] button to start the test. (The equipment can be switched between [uniformity test] and [sprayability test] by pressing [Drain] key when it is running.)
- 9) When the test is completed, the equipment will auto stop with the ring of the buzzer.

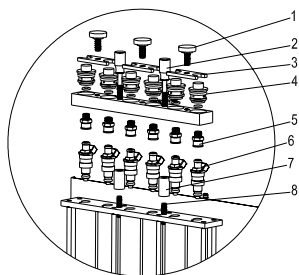

Fig. 05 for fuel top-supply injector

- 1-Plate bolt; 2-Riffle screw; 3-Crescent plate;
- 4-Fuel distributor stopper; 5-Adapter for fuel top-supply injector;
- 6-Injector; 7-Knurled nut; 8-Adjustable screw

Installing and testing procedures for side-supply injectors

- 1) Choose proper couplers for side-supply injectors (3) and proper O-rings, and mount them together. (Remember to apply a little lubricating grease.)
- 2) Mount the injectors on the couplers and install them onto the side-supply fuel distributor.
- 3) Mount the cross plate (1) and tighten it with bolts.
- 4) Mount the fuel distributor and injectors onto the fuel distributor supporter, and tighten them with two riffle screws (black). See Fig. 06.
- 5) Connect the injector pulse signal wire.
- 6) Before doing this test, press [Drain] button to drain the test liquid from the measuring cup if there is any.
- 7) Select [Uniformity/Sprayability test] on the control panel, set the corresponding parameters and press [Run] button to start the testing. (when it is running press the [⏏] key then press [run] key the system pressure will come back to the default pressure value When the function of item section is working)
- 8) When the testing is over, Injector Cleaner & Tester will auto stop at the ring of the buzzer.

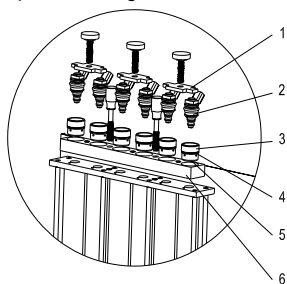

Fig. 06

- 1-Cross plate; 2-Fuel side-supply injector; 3- Coupler for fuel side-supply injector;
- 4,5-O-ring; 6-Side-supply fuel distributor

Note:

- ◆ While testing, Injector Cleaner & Tester can drain fuel by pressing [Drain] key. At default, solenoid valve is set at the closed state. Uniformity test can be done at this state. When [drain] key is pressed, solenoid valve will drain oil.
- ◆ The default cylinder number of the system is 0, which means that all injectors are working when Injector Cleaner & Tester is running. A specific

cylinder can be selected by setting the number of the cylinder.

- ◆ The system pressure can be adjusted by pressing [decrease pressure] / [increase pressure] key when testing.
- ◆ Keep the fluid level to at least 30 ml while testing. Foam will be produced in the liquid during injection. In order to prevent spillover, set the related parameter with reference to the following formula : $Pulse\ width(ms) \times time(s) \times speed(rpm) / 120\ 18000$
- ◆ This is for checking the uniformity of each cylinder. Injecting difference of all injectors on one vehicle should be kept within 2% during uniformity testing.
- ◆ During operating, the user can select parameter, such as RPM or PW, and then press [◀] or [▶] key to achieve the status of the simulation.
- ◆ Good injectors may have identical injecting angle, uniform spraying but no jet. Otherwise, replace the injector.
- ◆ In the sprayability test, a special electrical parameter--the minimum injection pulse width of injector--can be tested, to compare the injectors on the same engine. That is to set cylinder No., start the test from minimum injection pulse width, and then gradually increases the pulse width till the injector starts injection (observed with the help of backlight). The value set at this moment is the minimum injection pulse width, so the difference of minimum injection pulse width among these injectors could be observed.

Reverse flush

Injector Cleaner & Tester can also perform reverse flush by connecting with flush-back adaptor at [Uniformity/Sprayability test] mode. Reverse flush is a way to clean the injectors with the test liquid flowing from the outlet to the inlet of the injector. Reverse flush may remove the dirt inside the injector or the injector Strainer (Only for the top fuel supply injector).

Procedures:

- 1) Choose a reverse flush coupler and proper O-ring, and mount them under the fuel distributor.
- 2) Install the injectors in reverse direction (outlet upward, and inlet downward).
- 3) Choose a proper coupler according to the shape of the injector and put it under the injector.
- 4) Install the fuel distributor and the injector on the fuel distributor supporter with a proper adjustable screw and knurled nuts, and tighten two riffle screws (black). See Fig. 07.
- 5) Connect the injector pulse signal wire.
- 6) Set parameter, and press [Run] button to start cleaning(Injector Cleaner & Tester can switch between reverse flush by pressing [Drain] key when it is running press the [⏏] key then press run key

the system pressure will come back to the default pressure value When the function of item section is working).

- 7) When the cleaning is over, Injector Cleaner & Tester will automatically stop at the ring of the buzzer.

Note:

- ◆ *The system pressure can be adjusted by pressing [decrease pressure]/[increase pressure] key when performing reverse flush.*
- ◆ *It is advisable to press [Drain] key to avoid spillover of test liquid during reverse flush.*

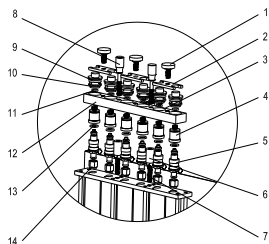

Fig. 07

- 1-Plate bolt; 2-Crescent plate; 3-Fuel distributor stopper;
- 4-Reverse adaptor; 5-Injector; 6-Knurled nut; 7-Adjustable screw;
- 8-Riffle screw; 9,10,11-O-ring; 12-Fuel distributor;
- 13-O-ring; 14-Couplers.

Leakage Test

Leakage test is to inspect the sealing conditions of the injector needle valve under system pressure and to find out if the injector is dribbling.

Procedures (For installation refer to Uniformity/ Sprayability Test):

- 1) Before doing leakage test, please press [Drain] button to drain the rudimental residual test liquid from the measuring cup.
- 2) Select [Leakage test] mode on the control panel. Press [run] key, the machine will work. At this time the system pressure can be adjusted by pressing [decrease pressure]/[increase pressure] key to observe dribbling from the injector the pressure is adjusted preferably 10% higher than manufacturer's specifications(Injector Cleaner & Tester can switch between leakage test by pressing [Drain] key when it is running press the [↕] key then press run key the system pressure will come back to the default pressure value When the function of item section is working).
- 3) When the test is over, the equipment will automatically stop and the buzzer will ring simultaneously.

Note:

- ◆ *In general the drip of the injector should be less than 1 drop within 1 minute (or in accordance with the specifications). The default time of the system is 1 minute.*

Injecting Flow Test

Injecting flow test is to check if the injecting flow in 15 seconds meets the specifications for injecting amount. The deviation reflects the wear or clogging in the injector, instead of electrical parameter variation.

Procedures (For installation refer to Uniformity / Sprayability Test):

- 1) Before this test, press [Drain] button to drain the test liquid from the measuring cup if there is any.
- 2) Choose [Injecting flow test] mode on the control panel, and press [Run] button to start the test. Adjust the fuel pressure by pressing [decrease pressure]/[increase pressure] key according to the injector specification(Injector Cleaner & Tester can switch between injecting flow test by pressing [Drain] key when it is running press the [↕] key then press run key the system pressure will come back to the default pressure value When the function of item section is working).
- 3) When the test is over, Injector Cleaner & Tester will stop automatically at the ring of the buzzer.

Auto. Test

Auto. test contains all above-mentioned tests (15-second injecting test, idle speed, middle speed, high speed, varying acceleration, varying deceleration, changing pulse width test). This function can test more comprehensive performance of injectors by simulating the various engine working conditions.

Procedures (For installation refer to Uniformity / Sprayability Test):

- 1) Before the test, press [Drain] button to drain all the test liquid in the measuring cups if there is any.
- 2) Select [Auto. test] mode on the control panel and set up the pressure value according to the injector specifications, select the test mode (mode 1, 2, or 3 are all available), and then press [Run] button to start the test.
- 3) Adjust the fuel pressure by pressing [decrease pressure]/[increase pressure] key when testing or press the [↕] key then press run key the system pressure will come back to the default pressure value When the function of item section is working)..
- 4) When the test is over, Injector Cleaner & Tester will auto stop at the ring of the buzzer.

What's the Model?

There are three Models in the Auto. test function Model I Model II & Model III, Model I & Model II shown in the flow chart below, the Model III equal to the Model I add the Model II.

Mode I for Automatic Test

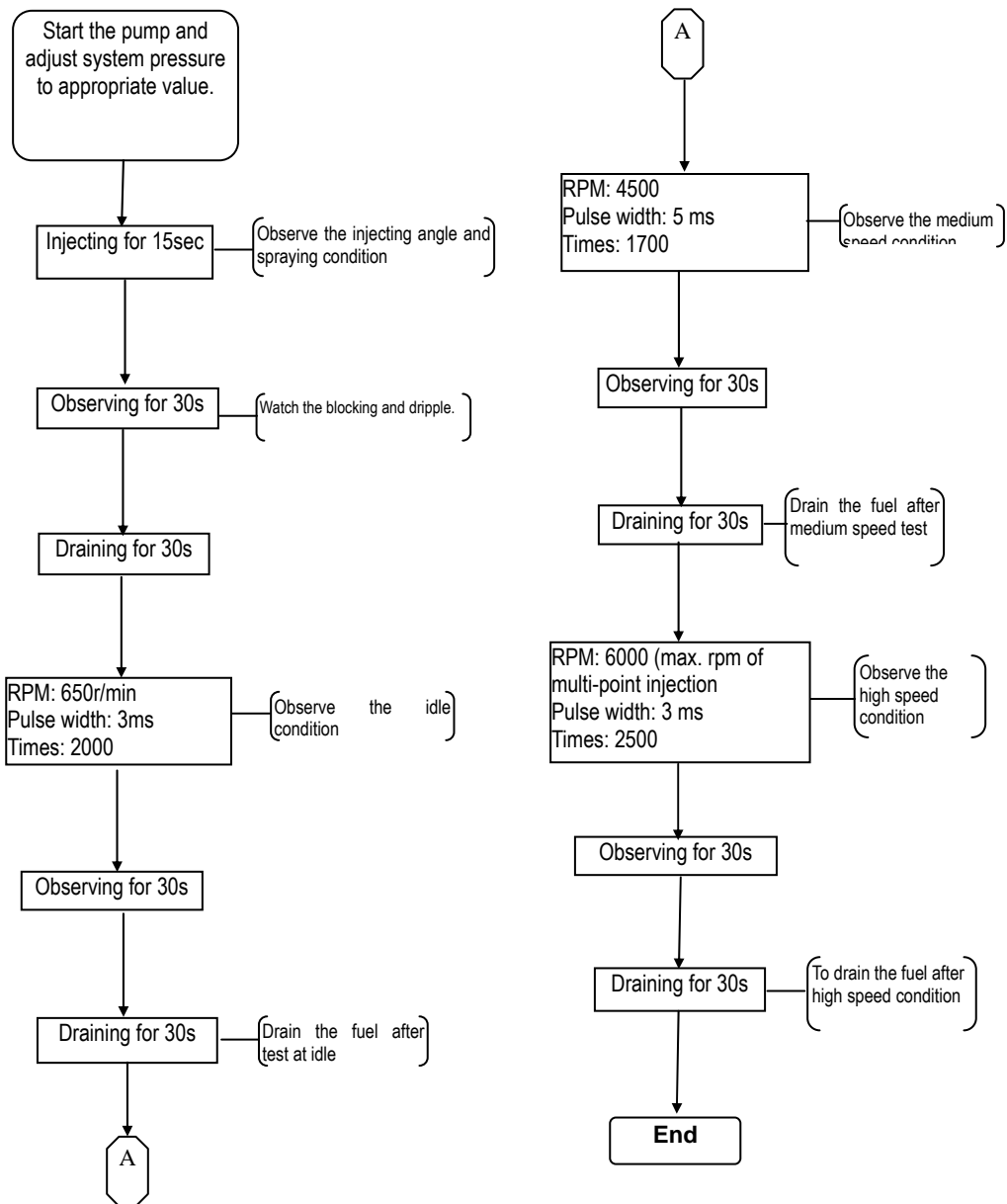

Mode II for Automatic Test

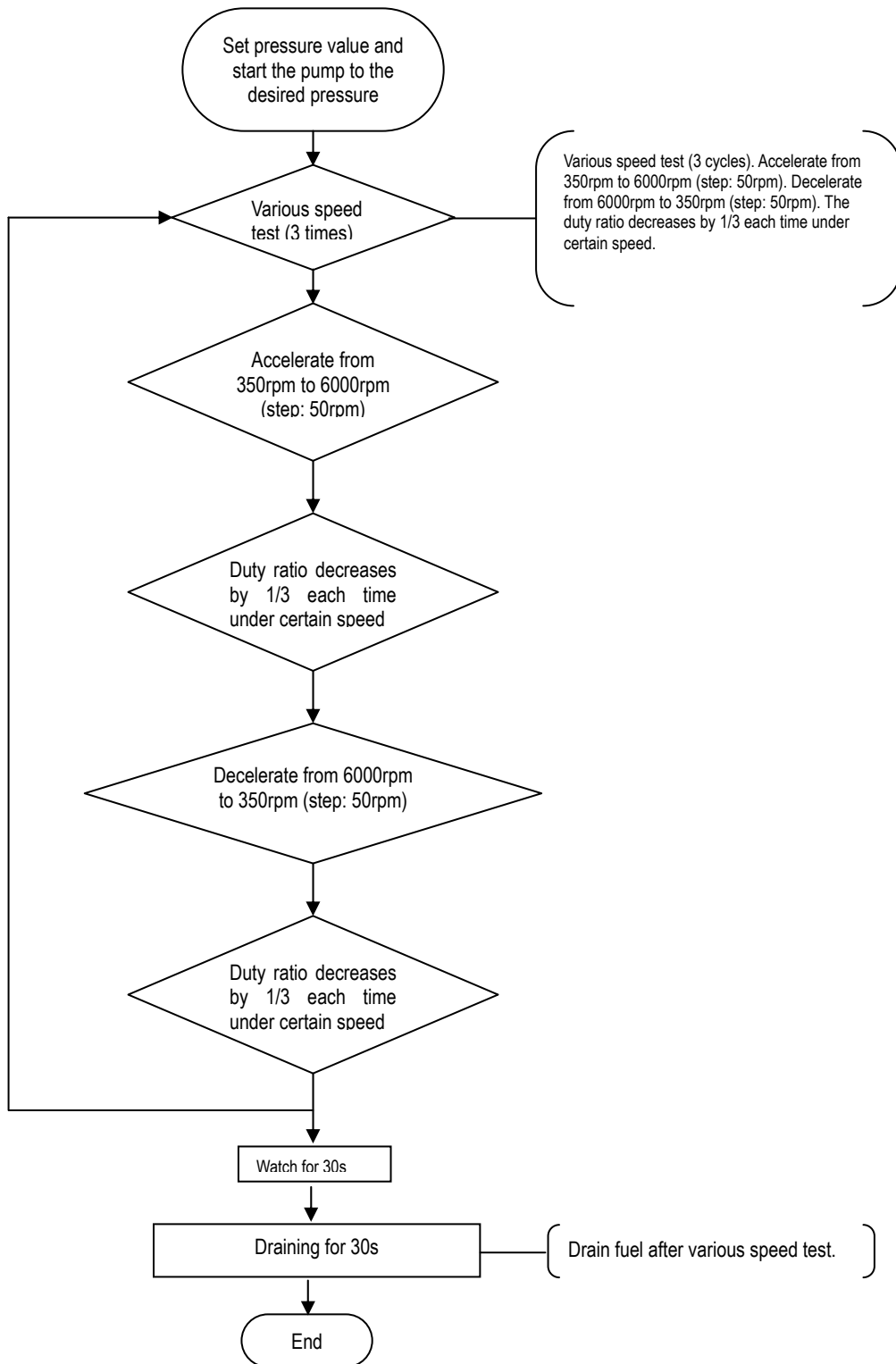

On-Vehicle Cleaning

After the engine has been in operation for a period of time, its fuel flow may be blocked or become un-smooth owing to buildup of dust and impurities in fuel channel. In addition, the carbon deposits and gum made by combustion can easily adhere to the injectors, inlet and outlet ports, inlet and outlet hoses, throttle and combustion chamber. So the fuel supply system, combustion chamber and injectors of the engine must be cleaned on a timely basis. On-vehicle cleaning is a solution that can save your time and labor.

Procedures

- 1) Please check if there is test liquid or detergent inside the fuel tank before on-vehicle cleaning. If test liquid is in the tank, replace it with detergent. The detailed procedure to be followed: remove the level indicator on the left of the main unit, and drain the test liquid inside fuel tank into a container. If the drained test liquid contains lots of impurities and can not be reused, please dispose it in the proper way and fill with new test liquid. If the drained test liquid is clean, please store it for later using.
- 2) Blend the detergent with the fuel at a certain ratio, and fill the mixture into the fuel tank. (Consult the user's manual of detergent for blending ratio.) Refer to the following table for filling amount, as shown in the following table:

No. of cylinders	4 cylinder	6/8 cylinder
Amount	about 800~1000ml	about 1500ml

- 3) The connection of engine fuel pipes has been shown in "Connecting" below.
- 4) Choose [On-vehicle cleaning] function on the control panel, and set the time and press [Run] button to start the test, then start the engine with park gear.
- 5) Refer to specifications required by various vehicle types to adjust system pressure by pressing [decrease pressure]/[increase pressure] key(The user can press the [↕] key then press run key the system pressure will come back to the default pressure value When the function of item section is working).Press [Stop] button at any time to stop the cleaning.

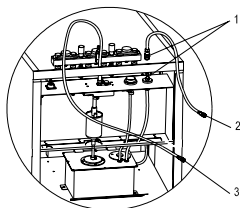

Fig.08

1- Fuel-return connector; 2- Fuel-return hose from engine; 3- Fuel-inlet hose to engine

Connecting

The hose line connection of the engine with return hose is shown as in Fig.09.

- 1) Disconnect the connections of fuel supply hoses (C, D) and fuel return hoses(A, B) of the engine fuel system(wrap the connector with towel when disconnecting the connector). Choose proper connectors and connect them to the B end and C end separately, and then connect the other ends to corresponding return hose and outlet hose of the unit. See Fig.09.
- 2) Connect the disconnected other ends (A, D) with proper hose, or remove the fuel pump fuse, or disconnect the power cable of engine fuel pump.

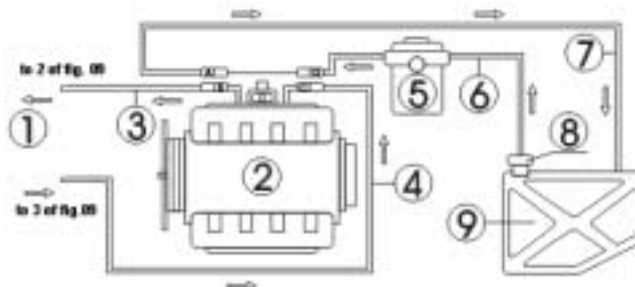

Fig.09

1-CNC Injector Cleaner & Tester; 2-Engine; 3- Fuel-return hose from engine; 4- Fuel-inlet hose to engine; 5-Auto filter; 6-Engine fuel supply hose; 7-Engine fuel return hose; 8- Auto fuel pump; 9-Auto tank

Without return hose connecting:

The hose line connection of the engine without return hose is shown as in Fig.10.

- 1) Disconnect the fuel supply hoses (E, F) of engine fuel system (wrap the connector when disconnecting the connector), and then choose a proper connector and connect it to the E end. Reconnect the fuel outlet hose of the unit well and make the fuel return hose hanging. See Fig.10.
- 2) Stop the other end of the disconnected end (F) with a proper stopper, (use when the fuel pump has the fuel return function only) or remove the fuse of fuel pump or disconnect the power cable of fuel pump.

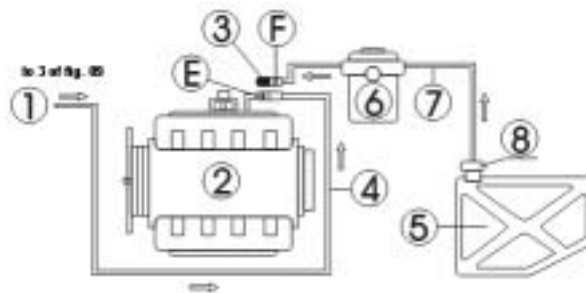

Fig.10

1-CNC Injector Cleaner & Tester; 2-Engine; 3-stopper; 4- Fuel-inlet hose to engine; 5-Auto tank; 6-Auto filter; 7- Engine fuel supply hose; 8-Auto fuel pump ;

Tidy up after on-vehicle cleaning

- 1) After the on-vehicle cleaning is completed, turn off the Auto Ignition Switches restitute the link of the Auto fuel hoses then start the Auto to check the leakage of Auto fuel system.
- 2) At last please clean the fuel tank and hose line with test liquid (if there is residual detergent inside fuel tank, please.). The detailed procedure is shown as follows: drain the liquid inside the fuel tank out and dispose it on the clean degree, and then fill little test liquid and turn on the power. Select "Leakage test" item and press [RUN] key to run the unit for about 2~3 minutes. When the unit stops, drain the test liquid from fuel tank and dispose the liquid as related regulation.
- 3) Tidy up and make preparation for the next cleaning.

Note:

- 1) *When cleaning, care must be taken as the detergent is inflammable. Prepare for a fire extinguisher.*
- 2) *Be sure that all hose lines are well connected and there is no leakage on the hose lines before performing cleaning.*

Maintenance

1. Transporting and Storing

It is advisable to transport the unit by hand or forklift.

1) Transporting

- A. Before being packed, the liquid inside the fuel tank should be drained completely to avoid overflowing as transporting.
- B. Move only by hand or lift with soft belt.
- C. No package no lifting tools or long-distance transportation.
- D. To prevent the unit from shocking and knocking, make sure it is on the base seat and in the packing case during transportation. Firstly pack the unit with the matter similar with plastic strip and add the filling material (such as foam or sponge, etc.) between the unit and packing case to avoid scratching the surface when the unit shakes.
- E. Make sure that the maximum incline angel does not exceed 45°. Do not place the unit up-side-down.

2) Storing

- A. Store only in dry area and keep away from water before the unit is unpacked.
- B. Store the machine in well-ventilated area and do not expose it to direct sun shine or rain.

3. Installation Environment

- A. Keep a distance of no less than 200mm between the unit and any wall or other substance. The unit

should be put in well-ventilated area. Make sure the temperature is within -10 ~ +40 .

- B. The unit has been well grounded for safety operation. Please confirm that the power socket is also well grounded.



Warning!

If an extension cord is used, the rated current should be equal to or greater than that of the equipment.

2. Vulnerable Parts

Vulnerable Parts List

Parts no.	Name	Specifications	Number
104130016	Upper seal gasket for glass tube	ϕ 40.2*22*3	CNC-601A/602A: 6PCS CNC-801A: 8PCS
104130017	Lower seal gasket for glass tube	ϕ 40.2*15*3	
199010019	Test liquid	4L	1PCS
199010035	Detergent	MFE-101 325 ml	2PCS
103100090	Fast connector (female)	SH20	CNC-602A 1CS CNC-601A/801A: 3CS
103260003	Filter		1 PCS
	Pump filter		1 PCS
	Various "O" ring		To see the Main Components and Parts list

Test Liquid and Detergent

Test liquid and detergent are shipped together with the unit. The test liquid is used in all tests except for on-vehicle cleaning, for which the mixture of fuel and detergent is used (the blending ratio of detergent and fuel is 1:4).The ultrasonic cleaning uses special ultrasonic detergent (or test liquid and detergent attached by the unit).

Note:

Impurities can be built up in the test liquid after being used for a period of time. Do not use contaminated test liquid, otherwise, injector and fuel pumps can be blocked. Drain the test liquid by removing the level indicator on the left of the main unit. It is better to clean the fuel tank with a little test liquid before the tank is filled in with new liquid.

Replacing O-ring

Replace the O-ring when it is deformed in order to avoid leaks during cleaning or testing.

Replacing Filter & pump filter

The filter tends to accumulate impurities after a period of using. Replace the filter periodically to ensure Injector Cleaner & Tester work normally. Select the [Leakage test] item to check if there is leak in the connector after

replacement.

I Replacing filter

The equipment filter has been fixed behind the main unit, if you want exchange it you must remove the back board and loose the clamp, take the filter out and exchange a new one.

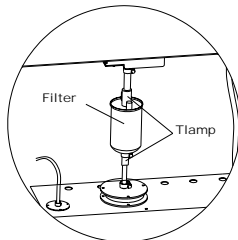

Fig.11

I Replacing fuel pump filter

The fuel pump filter has been fixed in the pump bottom, if you want exchange it you must remove the back board and remove the sealing cover for fuel pump then take out fuel pump sleeve, pull out the pump filter and exchange a new one.

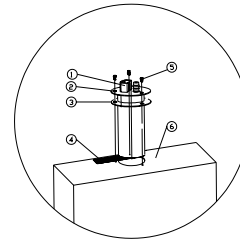

Fig.12

1-pump; 2- Sealing cover for fuel pump; 3- Fuel pump sleeve; 4-Pump filter; 5- Cross bulged screw; 6-Tuel tank.

3. Connection Diagram of Driving Board



Fig.13

Description:

No.	Part Name	No.	Part Name
1	Insert piece for power supply marked “-”	8	Socket for solenoid valve control cable
2	Insert piece for fuel pump marked “-”	9	Relay for solenoid valve
3	Insert piece for fuel pump marked “+”	10	Fuse for solenoid valve
4	Insert piece for power supply marked “+”	11	Insert piece for power supply marked “+”
5	Socket for level switch	12	Socket for injector pulse signal cables
6	Power socket	13	Insert piece for power supply marked “-”
7	Extension socket		

minutes, slightly turn the overflow valve with inner

4. Troubleshooting & Precautions

Troubleshooting

- The unit does not correspond when it is switched on.
Check the fuse at lower right side of the unit and replace it (AC 250V/5A) if it is damaged or broken.
- There is leakage in the fuel distributor coupler.
Check the o-rings and replace it if it is damaged or unfitted. Do not tighten the two raffle screws too tightly; otherwise, it may cause leakage.
- The fuel pressure drops slowly.
The fuel pressure can not drop to zero within 1 ~ 2

hexagonal spanner counterclockwise.

- The buzzer rings continually when there is no fuel pressure.
The machine has fuel-lack warning function and it will ring when the liquid in the fuel tank is lack, and then automatically switch off the fuel pump and injectors and returns to the stop state. Supply the detergent or test liquid to stop ringing. At this time, pressing [RUN] key is

necessary to rerun the fuel pump and injectors.

5. Draining the test liquid in glass tube thoroughly requires pressing the [Drain] key more times.

The solenoid valves will stop automatically after 15 seconds and it is necessary to drain more times if there is more liquid.

6. Malfunction code displaying E001.

The malfunction code of E001 is displayed when the level inside fuel tank is lower than that of the required level. At this time, the buzzer will ring to remind user to supply fuel. If this situation appears during running process, the machine will stop the fuel pump ten seconds later and make "RUN" indicator is on the flashing state. After the liquid is up to the required specification(Press "Drain" key to drain the liquid into the fuel tank to resume the liquid level if there is lots of liquid, otherwise, supply the liquid.), the buzzer will stop ringing. If you press [RUN] key, the machine will continue to run the interrupted work.

Precautions

- 1) Do not place anything on the control panel to prevent from breaking the measuring cup because it is made from vulnerable.
- 2) Do not disconnect hose before the system pressure reaches "0".
- 3) Always ensure that the provided power supply is well contacted with ground safely.
- 4) The unit is designed with warning function. When the level switch checks the liquid inside the tank less than the lowest line, the unit will utter the warning sound and meanwhile stop the fuel pump and injectors automatically, and then the unit returns to the stop state. The unit will stop warning until the liquid is supplied enough, at this time pressing the "RUN" key will run the unit again.
- 5) Clean the control panel in time and Keep the pulse signal cable away from the liquid.

Warning!

Unauthorized repair may cause the extension of faulty area of the unit, which will bring trouble to general repair. Under the state of turning on the power, the electrical system inside the unit contains the factor causing danger. Failure to comply with these instructions could result in death or serious injury.

Installation and Adjustment

1. Parts List and Structure Diagram of Fuel Path

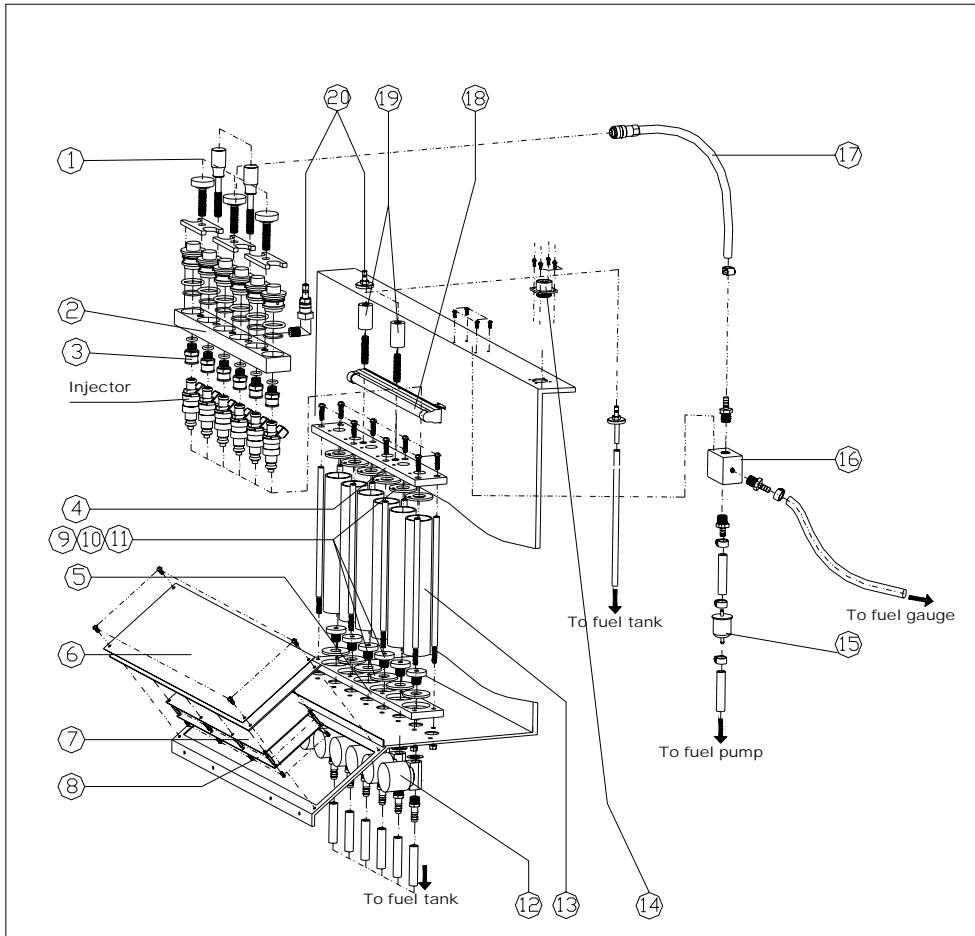

Fig.14

Parts list of the fuel path

Item	Part No.	Part name	Item	Part No.	Part name
1	103250008	Pressing screw 2	10	103200350	Inner hexagonal thread sleeve
2	103250002	6-cylinder distributor	11	104130017	Lower O-ring
	103250029	8-cylinder fuel distributor	12	102240040	Solenoid valve,AC220V
3	103250013	Top-supply connector 1		102240041	Solenoid valve,AC110V
	103250014	Top-supply connector 2	13	104110009	Glass tube
	103250015	Swiss thread adaptor for fuel top-supply injector	14	105020085	Navigator connector cable
4	103250016	Coarse thread adaptor for fuel top-supply injector	15	103260003	Gasoline filter
	103250003	6-cylinder upper plate	16	103240284	T-type blocker for CNC-602A
103250030	8-cylinder upper plate	103200705		T-type blocker for CNC-601A/801A	
5	103250004	6-cylinder lower seat plate	17	202010019	Quickly connect hose
	103250031	8-cylinder lower seat plate	18	102990017	Backlight for CNC-602A .AC110V
6	102040194	CNC-602A keys film		102990023	Backlight for CNC-602A .AC220V
	107040104	CNC-601a/801a keys film		102990020	Backlight for CNC-601,A/801AAC110V
7	Z205010263	Driving board (PCA)		102990021	Backlight for CNC-601,A/801AAC220V
8	Z 205010084	Control board (PCA)	19	103250007	Knurled nut
9	104130016	Upper O-ring	20	103240050	Quick connector(male)

2. Parts List and Structure Diagram of Fuel Distributor

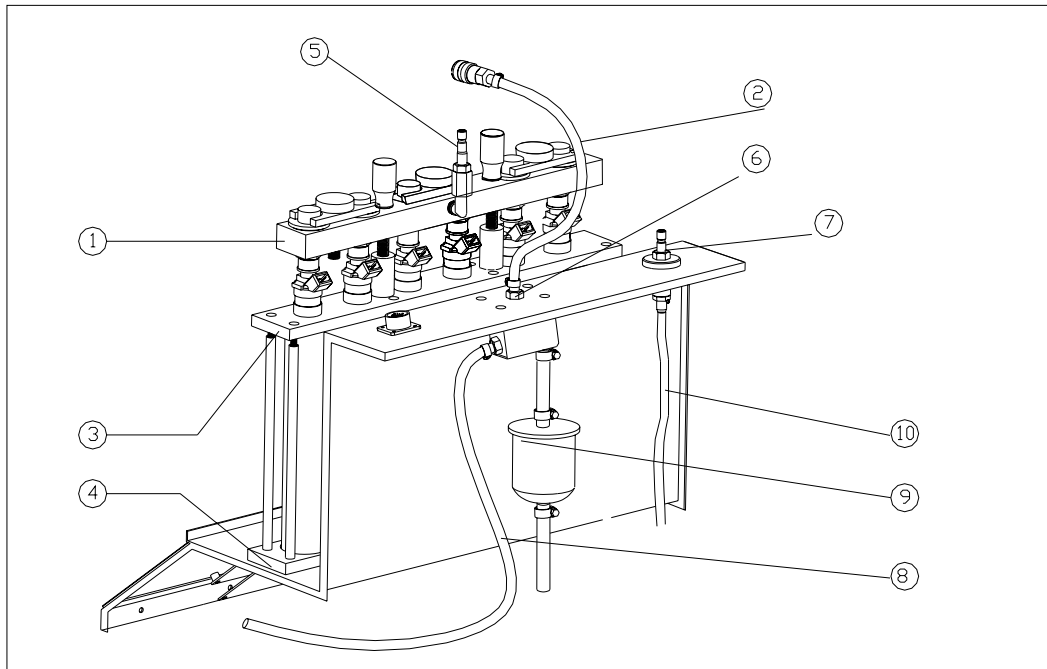

Fig.15

Parts list of fuel distributor:

Item	Part No.	Part name	Item	Part No.	Part name
1	103250002	6-cylinder fuel distributor	6	103240015	Tower connector
2	202010019	Quick connection hose	7	103240050	Quick connector
3	103250003	Upper plate	8	103240195	Copper hose, Φ2.5
4	103250004	Lower plate	9	103260003	Gasoline filter
5	103240050	Quick connector (male)	10	104120026	Return fuel viewer for on-vehicle cleaning

3. Parts List and Structure Diagram of Fuel Tank

Item	Parts No.	Parts Name
1	102990030	Fuel pump
2	X103200691	Sealing cover for fuel pump
3	X103200690	Fuel pump sleeve
4	No coding	Tank filter
5	No coding	Fuel tank
6	X103010124	Cross bulged screw,GB818-85 M4 x 12
7	X103010228	Screw M3x12
8	102100022	Vertical level Switch
9	104120026	PU hose for fuel level

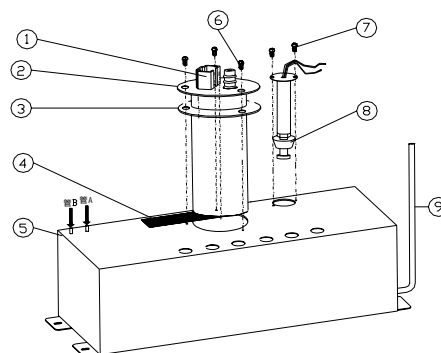























Fig.16

4. Main Components and Parts

Item	Parts No.	Parts Name	Number	Specifications	Remarks
1	201020068	6-cylinder fuel distributor package	1 set	For the Installation and fixation of injector	
	201021493	8-cylinder fuel distributor package	2 sets		
2	103250002	6-cylinder fuel distributor	1	Distributing the fuel from the quick connector to each injector	
	103250029	8-cylinder fuel distributor	2		
3	103250005	Crescent plate	3(4)	Tightening the fuel distributor stopper	
4	103250006	Press plate bolt	3(4)	Tightening the fuel distributor assembly	
5	103250014	Adaptor 2 for fuel top-supply injector	6 (8)	For some top-supply injectors	
6	103250028	Stopper for fuel distributor	6(8)	Installation of various of top-supply injectors and accessories	
7	103230107	Adjusting pole 2 for reverse flush	2	Length: 80mm	
8	103250007	Knurled nut	2	Installation between the fuel distributor assembly and upper press plate.	
9	103250008	Pressing screw 2	2	Tightening the fuel distributor assembly	
10	103250013	Adaptor 1 for fuel top-supply injector	6(8)	Bore: $\Phi 10.5$	
11	103250015	Swiss thread adaptor for fuel top-supply injector	6(8)	Be used for connecting swiss thread injector (M10×1).	
12	103250016	Coarse thread adaptor for fuel top-supply injector	6(8)	Be used for connecting coarse thread injector (M12).	
13	104990012	BUICK injector adaptor	6(8)	Be used for the connection of BUICK injector.	
14	103250018	Hexangular stopper	5(7)	Be used when the amount of injectors is less than 6.	

Item	Parts No.	Parts Name	Number	Specifications	Remarks
15	105020217	pulse signal connection cable 1	10	Be used for the connection of special injector, T=0.5	
16	105020218	pulse signal connection cable 2	10	Be used for the connection of special injector, T=0.8	
17	103260037	Ultrasonic cleaner assembly	1	Including: main unit, bracket and cover,AC220V	
	103200583			Including: main unit, bracket and cover,AC220V	
18	103250017	Reverse flush adaptor	6(8)		
19	101020131	6-cylinder Injector pulse signal cables	1	Provide the injectors pulse signal	
	105020083	8-cylinder Injector pulse signal cables			
20	199010019	Test liquid	1bottle	4L	
21	307030024	Detergent	2 bottles	MFE-101, 325mL	
22	206010154	On-vehicle cleaning kit	1set	Including: a set of adaptor and 2 fuel hoses; Optional Parts to CNC-602A	
23	104130022	O-ring	9	$\phi 32.5 \times 2.65$	
24	104130033	O-ring	18	$\phi 23.6 \times 1.8$	
25	104130032	O-ring	9	$\phi 15 \times 2.65$	
26	104130024	O-ring	18	$\phi 23.6 \times 2.65$	
27	104130023	O-ring	24	$\phi 20 \times 2.65$	

 Note:

Amount in the parenthesis is CNC-801A allocation amount.

Appendix 1: List of Optional Parts

No.	Part No.	Part Name	Number	Specifications	Remarks
1	103250137	Aux. Support assembly for side-supply injector	1	M20	
2	103250133	Adaptor B for reverse flush	6(8)	Inner bore: $\Phi 16.2$, Specification of the matched o-ring: 15×2.65	
3	103250132	Adaptor A for reverse flush	6(8)	Inner bore: $\Phi 18$, Specification of the matched o-ring: 17×2.65	
4	103250130	Adaptor for fuel top-supply Australia injector	6(8)	Bore of connected hose: $\Phi 8$	
5	103250026	Nissan Maxima adaptor	6(8)	Bore: $\Phi 26.3$	
6	103250025	Cadillac adaptor	6(8)	Bore: $\Phi 25.5$	
7	103250024	Nissan 324/Daewoo adaptor	6(8)	Bore: $\Phi 22.3$	
8	103250023	Mazda 929 adaptor	6(8)	Bore: $\Phi 25.9$	
9	103250022	Previa adaptor	6(8)	Bore: $\Phi 23.5$	
10	103250021	Bluebird adaptor	6(8)	Bore: $\Phi 26$	
11	103250020	Chevrolet adaptor	6(8)	Injector bore: $\Phi 29$ Specifications of O-ring: $\Phi 32.5 \times 2.65, \Phi 23.6 \times 2.65$	
12	103250012	Cross plate	3(4)	Forward cleaning for fuel side-supply injectors.	
13	103250011	Hexagonal underlay for reverse flush	6(8)	Bore: $\Phi 11$ Reverse flush for fuel side-supply injectors.	

No.	Part No.	Part Name	Number	Specifications	Remarks
14	103250010	Hexagonal underlay for reverse flush	6(8)	Bore: $\Phi 14$ Reverse flush for fuel side-supply injectors.	
15	103230060	Stopper for GM fuel distributor	1		
16	103230059	GM fuel distributor assembly	1	Bore of o-ring: $\Phi 30 \times 2.65$, $\Phi 12.5 \times 2.65$	
17	103230058	Chevrolet Cavalier adaptor	2	Bore: $\Phi 23$	
18	103230051	Nissan single-point adaptor for fuel top-supply	2	$\Phi 5$	
19	103230050	Ford single-point base seat	2	Inner bore: $\Phi 14$	
20	103230049	Single-point aux. Bracket	1		
21	103230048	Single-point Aux. base seat	1	G1/4"	
22	103230041	Reverse-flush base seat for Australia injector	6(8)	Bore: $\Phi 11.5$	
23	103230040	Ultrasonic base seat for Zhonghua injector	6(8)	Bore: $\Phi 14$	
24	103230039	Reverse-flush base seat for Zhonghua injector	6(8)	Bore: $\Phi 14$	
25	103230038	Reverse-flush adaptor for Zhonghua injector	6(8)	Bore: $\Phi 14$	

 Note:

Amount in the parenthesis is CNC-801A allocation amount.

Appendix 4: Pressure Gauge of Injection System

COMPANY	MODEL	SYSTEM PRESSURE (MPa)
TOYOTA	TOYOTA 3.0	0.284
	PREVIA	0.27—0.33
	LEXUS 300 400	0.265—0.304
	CAMRY 3.0	0.265—0.304
	LAND CRUISER	0.30
	COROLLA	0.27—0.31
HONDA	ACCORD 2.0 2.2	0.285
	CIVIC 1.5L	0.255—0.285
	LEGEND 3.2L	0.27—0.304
NISSAN	BLUE BIRD	0.25
	MAXIMA	0.25
	300EX	0.206—0.255
MITSUBISHI	V63000	0.35
MAZDA	323	0.20—0.22
	626	0.25—0.29
	929	0.25—0.29
BMW	528	0.27—0.29
GM	BUICK CENTURY	0.29—0.33
	BUICK PARK AVENUE	0.29—0.33
	CADILLAC 5.7	0.29—0.33
	LUMINA	0.23—0.30
	CORSICA	0.25—0.30
FORD	TEMPO 2.3L	0.28
	LINCOLN TOWN	0.206—0.308
CHRYSLER	CHEROKEE 213	0.273
	DODGE 3.3L DODGE CARAVAN	0.337
HYUNDAI	SONATA	0.265—0.275
DAEWOO	DAEWOO	0.28—0.30
AUDI	6 CYLINDER	0.24—0.27
	5, 4 CYLINDER	0.45—0.50
VOLKSWAGEN	JETTA	0.27—0.29
VOLVO	VOLVO	0.23—0.30

Warranty

THIS WARRANTY IS EXPRESSLY LIMITED TO PERSONS WHO PURCHASE LAUNCH PRODUCTS FOR PURPOSES OF RESALE OR USE IN THE ORDINARY COURSE OF THE BUYER'S BUSINESS.

LAUNCH electronic product is warranted against defects in materials and workmanship for one year (12 months) from date of delivery to the user. This warranty does not cover any part that has been abused, altered, used for a purpose other than for which it was intended, or used in a manner inconsistent with instructions regarding use. The exclusive remedy for any automotive meter found to be defective is repair or replacement, and LAUNCH shall not be liable for any consequential or incidental damages. Final determination of defects shall be made by LAUNCH in accordance with procedures established by LAUNCH. No agent, employee, or representative of LAUNCH has any authority to bind LAUNCH to any affirmation, representation, or warranty concerning LAUNCH automotive meters, except as stated herein.

Disclaimer

THE ABOVE WARRANTY IS IN LIEU OF ANY OTHER WARRANTY, EXPRESSED OR IMPLIED, INCLUDING ANY WARRANTY OF MERCHANTABILITY OR FITNESS FOR A PARTICULAR PURPOSE.

Order Information

Replaceable and optional parts can be ordered directly from your LAUNCH authorized tool supplier. Your order should include the following information:

1. Quantity
2. Part number
3. Item description

Customer Service

If you have any questions on the operation of the unit, please contact us:

Tel: 400-830-5166,

Fax: +86-755-84528830,

E-mail: overseasales@cnlaunch.com.

If your unit requires repair service, return it to the manufacturer with a copy of the sales receipt and a note describing the problem. If the unit is determined to be in warranty, it will be repaired or replaced at no charge. If the unit is determined to be out of warranty, it will be repaired for a nominal service charge. Send the unit pre-paid to:

Attn: Overseas Department
LAUNCH Industrial Park,
North Wuhe Avenue,
Banxuegang Industrial Park,
Longgang Dist.,
Shenzhen, Guangdong Province
P.R. China